

pdp11

**H720
power supply and
mounting box
user's manual**

digital

**H720
power supply and
mounting box
user's manual**

Copyright © 1976 by Digital Equipment Corporation

The material in this manual is for informational purposes and is subject to change without notice.

Digital Equipment Corporation assumes no responsibility for any errors which may appear in this manual.

Printed in U.S.A.

The following are trademarks of Digital Equipment Corporation, Maynard, Massachusetts:

DEC	DECtape	PDP
DECCOMM	DECUS	RSTS
DECsystem-10	DIGITAL	TYPESET-8
DECSYSTEM-20	MASSBUS	TYPESET-11
		UNIBUS

CONTENTS

		Page
CHAPTER 1	INTRODUCTION	
CHAPTER 2	POWER SUPPLY	
2.1	INTRODUCTION	2-1
2.2	GENERAL DESCRIPTION	2-1
2.2.1	AC Power Distribution	2-2
2.2.2	Unregulated DC Supply	2-2
CHAPTER 3	MOUNTING BOX	
3.1	SCOPE	3-1
3.2	DESCRIPTION	3-1
3.3	MODELS	3-1
CHAPTER 4	INSTALLATION	
4.1	INTRODUCTION	4-1
4.2	SYSTEM CONFIGURATIONS	4-1
4.3	INSTALLATION PLANNING	4-1
4.3.1	Space Requirements	4-3
4.3.2	Environmental Requirements	4-3
4.3.3	Power Requirements	4-3
4.3.4	Cable Requirements	4-4
4.4	INSTALLATION	4-4
4.5	DATA SHEETS	4-5

ILLUSTRATIONS

Figure No.	Title	Page
3-1	Basic Mounting Box	3-2
4-1	PDP-11 Position Assignments	4-3

TABLES

Table No.	Title	Page
2-1	H720 Power Supply Models	2-1
3-1	Mounting Box Models	3-2
4-1	PDP-11 System Configurations	4-2

CHAPTER 1

INTRODUCTION

This manual provides the user with information on the PDP-11 Power Supply and Mounting Box; their system configurations and installation procedures.

The H720 Power Supply is described briefly in Chapter 2.

NOTE

Sections of this manual refer to specific engineering drawings which are contained in the second volume entitled *H720 Power Supply and Mounting Box, Engineering Drawings*. The drawings in the above manual reflect the latest print revisions.

Chapter 3 comprises descriptions of the modular concept of the PDP-11 System and the four available mounting box models.

Installation procedures are covered in Chapter 4, which describes all applicable PDP-11 System configurations and planning requirements. The remainder of the chapter contains a series of data sheets on the six basic system configurations and the major hardware components, including a brief description of the item, specifications, and installation drawings.

CHAPTER 2

POWER SUPPLY

2.1 INTRODUCTION

The H720 Power Supply provides both regulated and unregulated ac and dc power for the PDP-11 System. This supply furnishes all power required by components mounted in either a basic or extension mounting box.

The physical dimensions and electrical specifications of the H720 Power Supply are given in the appropriate data sheet in Chapter 4 of this manual.

2.2 GENERAL DESCRIPTION

The H720 Power Supply provides both regulated and unregulated ac and dc power for the PDP-11 System. There are two basic versions of the power supply and two models of each version, as shown in Table 2-1.

Table 2-1
H720 Power Supply Models

Version	Model No.	Remarks
A & B	H720-A H720-B	Models A and B are identical except for input voltage requirements.
C & D	H720-C H720-D	Models C and D are door-mounted versions of models A, B, E, or F. A metal frame accepts the entire power supply for use with some peripheral controllers.
E & F	H720-E H720-F	Models E and F are identical except for input voltage requirements. Ac control and increased +5V current capabilities distinguish these models from the A and B models.

The H720 Power Supply, designed to mount in the BA11 Mounting Box, furnishes all power required by components in either a basic or extension mounting box. The input voltage may be either 120V or 240V at 50/60 Hz. Regulated outputs of +5V at 16 amps (A and B version), or at 22 amps (E and F version), and -15V at 10 amps (both versions) are available.

Unregulated outputs of +8V at 1.5 amps and -25V at 1.5 amps are also available. In addition, a sine wave clipped both at ground and +5V (nominal) is provided for the line clock, and a pair of logic levels (AC LO and DC LO) are provided to warn the processor of imminent power failure.

Switching mode regulation, employed in the +5V and -15V supplies, offers the advantages of compactness and high efficiency over an analog-type regulator at the expense of a slightly greater circuit complexity. Dynamic over- and under-voltage protection and current-limiting are implemented on the two regulated voltages.

2.2.1 AC Power Distribution

Incoming ac power is applied through fuse F1 of the H720 Power Supply, and then routed above the fans to the OFF/POWER/PANEL LOCK switch on the front panel. (Both ac lines connect to this switch.) Power is then routed to the back of the supply where two accessory outlets are provided, and is then applied through fuse F2 to the primary winding of the power transformer. A split primary with jumpers is used to allow operation at either 120V or 240 Vac. One pair of fans is connected across each primary winding to ensure that the fans always receive 120 Vac.

Models E and F of the H720 have four features in the ac control section that distinguish them from the A and B models. These features are:

- a. The incoming ac line uses a circuit breaker rather than a fuse.
- b. The control portion permits switchable remote and local control to provide the capability of one unit controlling several others (see the schematic of the control portion).
- c. The POWER switch on the front panel of the computer switches only a single ground control line to activate the ac input, rather than switching both sides of the ac line as in the A and B version.
- d. A thermal detector is used to turn off the supply in the event of excessive temperature.

The remainder of the ac portion of the E and F versions is essentially the same as that of the A and B versions.

2.2.2 Unregulated DC Supply

The basic ± 25 Vdc are developed from a pair of full-wave bridge rectifier circuits connected to the center-tap of the secondary winding of the power transformer. A 22,000 μ F capacitor on each dc voltage leg provides filtering. In addition, there is a pair of taps (approximately 8V rms) on either side of the center tap. This voltage is full-wave rectified but unfiltered, and provides power for the console indicator lamps.

CHAPTER 3

MOUNTING BOX

3.1 SCOPE

The PDP-11 System is modular in concept and consists of a number of basic building blocks, known as system units, that are housed in a mounting box. This section discusses only the basic PDP-11 Mounting Box. A description of system units and cables is included in the maintenance manuals and handbooks for the specific PDP-11 system involved. Various methods of installing mounting boxes and descriptions of various system configurations are presented in Chapter 4 of this manual.

3.2 DESCRIPTION

The basic mounting box (see Figure 3-1) is designed to house the system units that make up a PDP-11 System. The box also includes a space for mounting the H720 System Power Supply. The mounting box contains four fans for forced air cooling, an insulated top cover to prevent debris from falling into the wire-wrap pins (necessary because the system units are mounted with the pins up and the modules down), and a foam-lined bottom cover which is both a module retainer and minimizes module vibration. The bottom cover also serves as part of the air plenum to ensure adequate cooling. The mounting box is fabricated from zinc-plated steel to resist corrosion; its dimensions are given in drawing D-UA-11/20-0-0.

3.3 MODELS

There are four models of mounting boxes, each a variation of the box described above. The prime differences among the four models are the type of front panel used and the mounting hardware.

The basic box is used to house the PDP-11 basic system and includes either a programmer's console or controller console as the front panel. The basic box may be supplied with either slides for rack-mounting or a table-top decorative cabinet.

The extension box is used to house additional system components (expanded memory, interface modules, etc.) and includes a blank front panel rather than a console. It also may be supplied with either tilt-slides or a table-top cover.

The four mounting box models are listed in Table 3-1.

CHAPTER 4

INSTALLATION

4.1 INTRODUCTION

This chapter provides installation information and physical specifications for PDP-11 Systems. Because of the number of possible system configurations, a brief description of all PDP-11 Models is included. Subsequent paragraphs discuss requirements that must be considered for installation planning and the appropriate installation procedures. The final portion of this chapter includes a series of data sheets that contain specifications and drawings on major hardware components.

4.2 SYSTEM CONFIGURATIONS

Basic PDP-11 Systems are available in 18 different configurations. Configurations differ in mounting methods, input power requirements, inclusion of a Teletype[®], and support functions supplied. Six of these configurations represent standard systems, the remaining twelve represent systems designed for use by OEM's. All 18 configurations are briefly mentioned in Table 4-1; however, only the six standard configurations are described in detail in Paragraph 4.5. The OEM configurations are physically identical to the standard, with the following exceptions:

- a. The Teletype and front panel logo are optional.
- b. Support functions (i.e., one set of documentation per system, training courses, maintenance) are not included.

In addition to the basic system, customers can order DEC options and peripherals. Figure 4-1 shows a standard DEC cabinet and indicates preferred position assignments. These assignments have been chosen considering ease of control and cable lengths. Any PDP-11 equipment not shown on the drawing may be mounted as desired in the remainder of the cabinet or in other cabinets. Note that the top and bottom cabinet spaces are not used; the top space is too high for easy access, and the bottom space does not allow the drawer to be tilted.

4.3 INSTALLATION PLANNING

This section provides electrical, physical, and environmental requirements that must be considered prior to installation in order to ensure an efficient PDP-11 Computer installation.

[®]Teletype is the registered trademark of Teletype Corporation

**Table 4-1
PDP-11 System Configurations**

Configuration Codes			
Basic System With Teletype	OEM System With Teletype	OEM System Without Teletype	Mounting Method
A	D	H	Rack-mountable, with tilt-slides
B	E	J	Table-top model with cover
C	F	K	Rack-mounted in cabinet

Power Codes	
Designation (Power Supply Type)	Input Power Requirements
A	115V, 50/60 Hz
B	230V, 50/60 Hz

NOTES: 1. Model codes are used as follows:

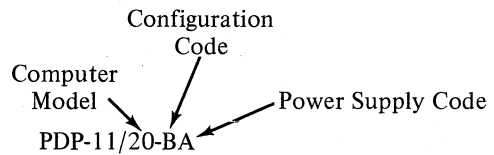

2. Examples are: PDP-11/20-BA is basic system with Teletype, table-top model, 115V version
 PDP-11/20-HB is OEM System, without Teletype, rack-mountable, 230V version

4.3.1 Space Requirements

Access space must be provided at the installation site to accommodate the PDP-11 System and related peripherals. Space must be adequate to allow access to all doors and panels for maintenance.

The PDP-11 System is available in rack-mountable, table-top, or cabinet-mounted configurations. Dimensions for each configuration, including drawings, are given in the data sheets in Paragraph 4.5. If customer-supplied cabinets are to be used, the customer should consult the supplier's documents to ensure that sufficient space is allowed for the cabinets.

The minimum service clearance on all standard DEC computer cabinets is 8-3/4 in. at the front and 14-7/8 in. at the back.

The Teletype dimensions and service area requirements are also given in the appropriate data sheets in Paragraph 4.5. Because of the Teletype signal cable, the Teletype must be located within eight ft of the computer.

4.3.2 Environmental Requirements

Ambient temperature at the installation site can vary between 50° F and 122° F (10° C and 50° C). To extend the life expectancy of the system, however, it is recommended that the temperature at the installation site be maintained between 70° F and 85° F (20° C and 30° C).

All exposed surfaces of DEC cabinets and hardware have been treated to prevent corrosion, but exposure of systems to extreme humidity for long periods of time should be avoided.

The system operating environment should be within the relative humidity range of 20% to 95% (non-condensing).

4.3.3 Power Requirements

Systems with an A power code in the model designation (indicating an H720-A Power Supply) require a source of 115V (±10%), 50/60 Hz (47 to 63 Hz), single-phase power capable of supplying at least 8A (6A for the computer, 2A for the Teletype). Power dissipation is 400W for the computer and 150W for the Teletype. If additional mounting boxes and power supplies are added to the basic system, additional power receptacles at the site are required.

A standard 15-ft, 3-prong, U-ground, 15-A power cord is provided on the rear of the PDP-11 System for connection to the power source. The Teletype unit plugs into the rear of the PDP-11 Mounting Box and does not require a separate receptacle.

All free-standing cabinets require an independent 115V receptacle to provide power for the cabinet fans.

Systems with a B power code in the model designation (indicating an H720-B Power Supply) require a source of 230V (±10%), 50/60 Hz (47 to 63 Hz), single-phase power capable of supplying at least 5A (3A for the computer, 2A for the Teletype). If additional mounting boxes and power supplies are added to the basic system, additional power receptacles at the site are required.

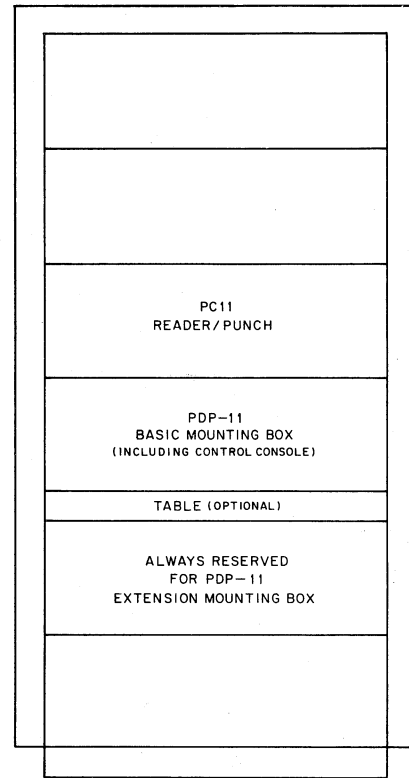

11-0113

Figure 4-1
PDP-11 Position Assignments

A standard 15-ft, 3-conductor power cable with pigtails is provided on the rear of the PDP-11 System for connection to the power source. The Teletype unit plugs into the rear of the mounting box.

All free-standing cabinets require an independent 230V receptacle to provide power for the cabinet fans.

4.3.4 Cable Requirements

Whenever an extension mounting box is used, an external Unibus Cable (BC11) is the only signal connection required between mounting boxes. This external Unibus cable may also be used to connect other peripherals to the PDP-11 System. The BC11 Cable Assembly may be purchased in various lengths but the maximum combined (internal and external) Unibus cable length is limited to 50 ft.

The length of the Teletype signal cable is such that it restricts the location of the Teletype to within eight ft of the computer.

4.4 INSTALLATION

This paragraph covers installation of only the basic PDP-11 System. A section on installation of peripherals and options is not required, because of the modular and Unibus concepts of the system. To install a peripheral, for example, it is necessary only to insert the system unit in the mounting box and connect a Unibus cable between the mounting box and peripheral. Details of interface hardware are included in the *Unibus Interface Manual*.

Installation of a PDP-11 System requires no special tools or equipment. A fork-lift truck (or other pallet-handling equipment) and normal hand tools should be available for receiving and installing the equipment.

The installation procedure is as follows:

Step	Procedure
1	Remove the shipping straps with shears, remove the packing material, and remove the cardboard crate to disassemble the wooden corner supports.
2	Carefully place the PDP-11 Mounting Box (or cabinet, depending on type of system) in the desired location.
3	Open the Teletype carton and remove the packing material. Remove the back cover from the stand. Remove and unwrap the copyholder, chad box, and power pack. Remove the stand from the shipping carton. Remove the Teletype console from the carton, holding it by means of the wooden pallet attached to the bottom. Snap the power pack in place at the top of the rear side of the Teletype stand.
4	Remove the Teletype console from the pallet and mount it on the stand. Connect the Teletype console to the power pack. (A 6-lead cable attached at the console is connected to the power pack by means of a white plastic Molex 1375 female connector which mates with a male output plug on the power pack.) Pass the 3-wire power cable and the 7-conductor signal cable (which is terminated in a type W076 cable connector module) through the opening at the lower left-hand corner of the Teletype stand, then replace the back cover of the stand by means of the two mounting screws.
5	Dress the Teletype cable under the PDP-11 Cabinet and through the large opening at the right rear of the mounting box (the Unibus also passes through this opening). Connect the cable to the 8-pin connector on the KL11-A Teletype Control module.

(continued on next page)

Step	Procedure
6	Connect the 3-prong male connector of the Teletype power cable to either one of the two 120V outlets at the rear of the mounting box.
7	Set the OFF/POWER/PANEL LOCK switch on the programmer's console to the POWER position.
8	Install a roll of printed paper into the Teletype Keyboard/Printer, and install a tape in the punch as described in the <i>PDP-11/20 System Manual</i> .
9	Set the Teletype LINE/OFF/LOCAL switch to LINE. Press the punch ON pushbutton. Strike several keys and note whether or not the printer and punch operate. Check operation of the printer with the LINE/OFF/LOCAL switch set to LOCAL. After completion of these checks, set the switch to OFF.
10	Set the OFF/POWER/PANEL LOCK switch on the programmer's console to OFF. This completes the installation of a standard PDP-11 System. Before using the system, verify system operating capability by performing power supply checks and running the complete set of diagnostic programs.

4.5 DATA SHEETS

The following data sheets contain information on the six basic PDP-11 System configurations, as well as major hardware components such as mounting boxes, Teletypes, power supplies, etc.

Each data sheet is devoted to a single item and includes a brief description, list of components, specifications (dimensions and power), and installation drawings.

Data sheets are provided for the following:

- a. Models AA & AB Rack-Mountable Systems
- b. Models BA & BB Table-Top Systems
- c. Models CA & CB Rack-Mounted (cabinet) Systems
- d. LT33 Teletype
- e. LT35 Teletype
- f. H720 Power Supply
- g. H960-CA Freestanding Base Cabinet
- h. H952-HA Freestanding Programmer's Table
- i. BA11-EC Extension Mounting Box (Table-Top Model)
- j. BA11-ES Extension Mounting Box (Rack-Mountable Model)

NOTE

The BA11-CS and BA11-CC basic mounting boxes are included in items *a.* and *b.* above, respectively.

DESCRIPTION

Systems designated as either Model AA or AB are mounted in a basic mounting box which includes tilt-and-lock chassis slides for cabinet installation. The mounting box is designed to fit either DEC cabinets or customer-supplied standard 19-inch RETMA cabinets. The only difference between the two models is the input power requirements.

COMPONENTS

Both models consists of a basic BA11-CS Mounting Box and either an H720-A (115V) or H720-B (230V) Power Supply. The mounting box is supplied with the appropriate power supply already installed.

BA11-CS Mounting Box

Tilt-and-lock chassis slides

Cooling fans (four)

Filter

11/20 Programmer's Console or 11/10 Controller Console

H720 Power Supply

Power Supply (refer to power supply sheet for description of both A and B models)

15 ft of appropriate power cord with ground wire

SPECIFICATIONS

Size: 10-1/2 in. high, 19 in. wide, 23 in. deep

Weight: 90 lbs. (approximate – includes processor, console, and 4K of memory)

Power: H720-A – 120V \pm 10%, 47-63 Hz, 6A, single-phase
H720-B – 230V \pm 10%, 47-63 Hz, 3A, single-phase

**MODELS AA and AB
RACK-MOUNTABLE SYSTEMS**

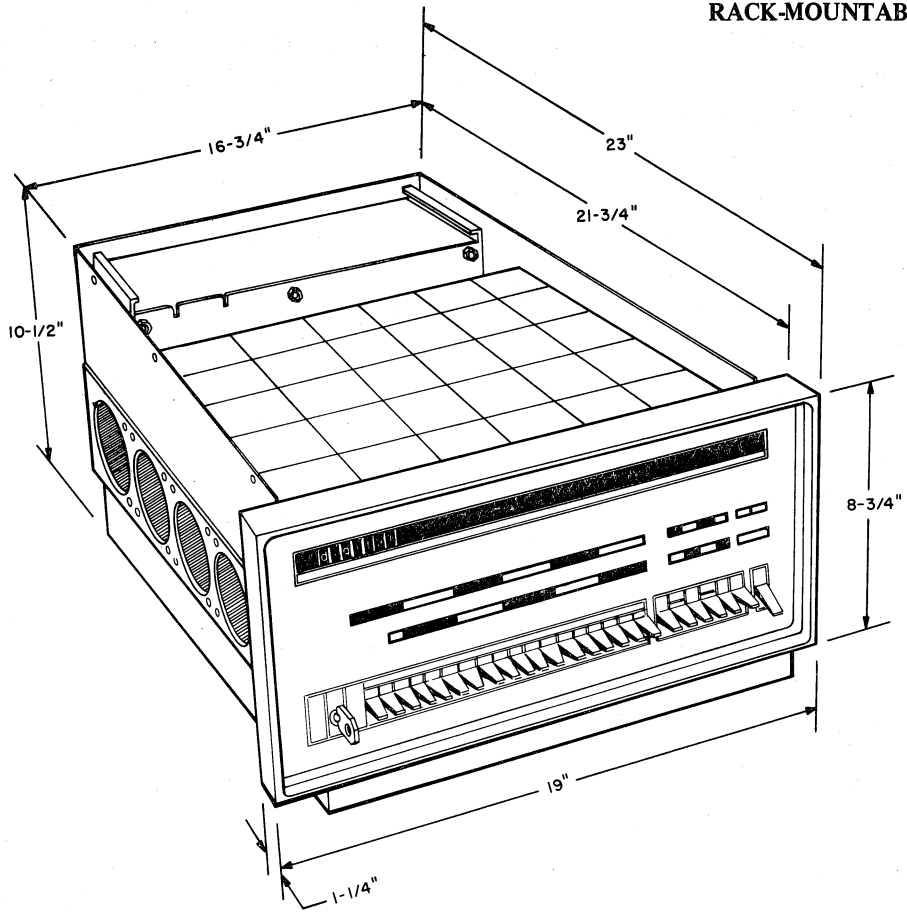

Overall Dimensions

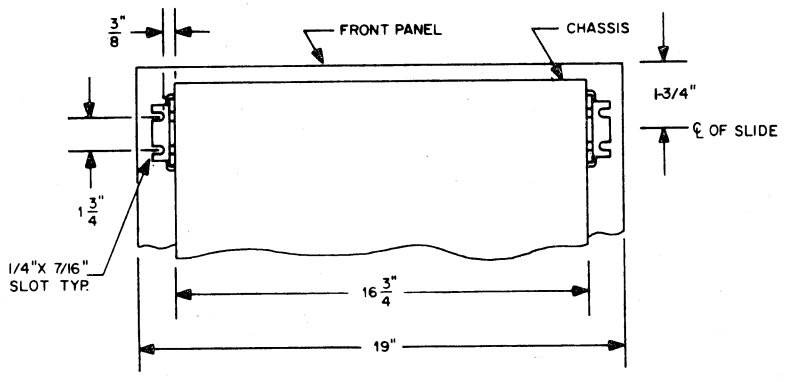

Rear View of Mounting Hardware

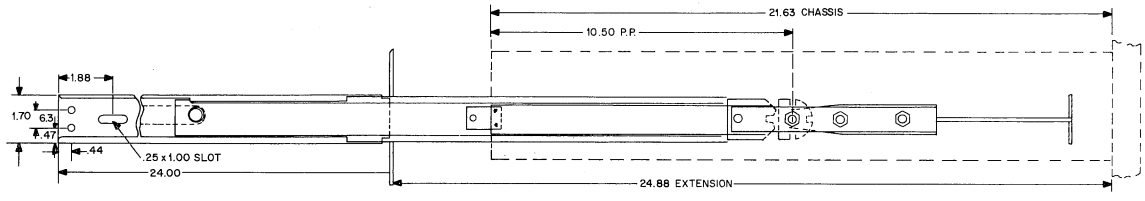

Side View of Mounting Hardware

DESCRIPTION

Systems designated as either Model BA or BB are mounted in a table-top mounting box which includes a decorative, protective cover. The only difference between the two models is the input power requirements.

COMPONENTS

Both models consist of a BA11-CC Mounting Box and either an H720-A (115V) or H720-B (230V) Power Supply. The appropriate power supply is furnished already installed in the mounting box.

BA11-CC Mounting Box

Protective cover

Cooling fans (four)

Filter

11/20 Programmer's Console or 11/10 Controller Console

H720 Power Supply (See power supply sheet for description of both A and B models.)

15 ft of power cord with ground wire

SPECIFICATIONS

Size: 11 in. high, 20 in. wide, 23-5/8 in. deep

Weight: 100 lbs. (approximate – includes processor, console, and 4K of memory)

Power: H720-A – 120V \pm 10%, 47-63 Hz, 6A, single-phase

H720-B – 230V \pm 10%, 47-63 Hz, 3A, single-phase

**MODELS BA and BB
TABLE-TOP SYSTEMS**

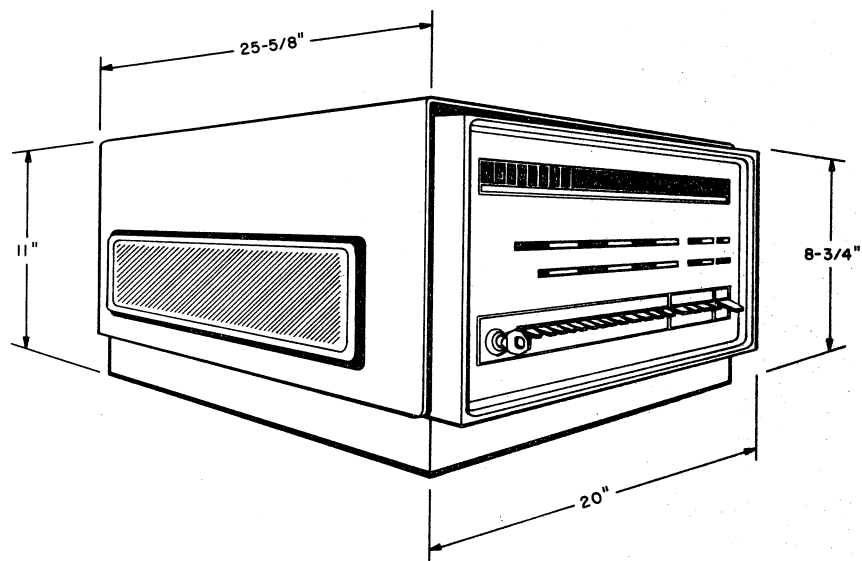

DESCRIPTION

Systems designated as either Model CA or CB are delivered to the customer already mounted in a DEC free-standing cabinet. In addition to the space occupied by the basic mounting box, the cabinet contains two additional spaces for holding extension mounting boxes, basic mounting boxes, or other PDP-11 equipment. The only difference between the two models is the input power requirements.

COMPONENTS

Both models consist of a BA11-CS Basic Mounting Box, an H960-CA Cabinet, and either an H720-A (115V) or H720-B (230V) Power Supply. An optional freestanding programmer's table may also be included.

BA11-CS Mounting Box

- Tilt-and-lock chassis slides
- Cooling fans (four)
- Filter
- 11/20 Programmer's Console or 11/10 Controller Console

H720 Power Supply

- Power Supply (refer to power supply sheet for description of both A and B models)
- 15 ft of appropriate power cord with ground wires

H960-CA Freestanding Base Cabinet

- Fan assembly (in top of cabinet)
- Power distribution panel
- Extension feet
- Front panel bezels (5 maximum)

H952-HA Freestanding Programmer's Table (optional)

SPECIFICATIONS

Size: Cabinet – 71-1/2 in. high, 22 in. wide, 39 in. deep
Table – 27 in. high, 19 in. wide, 20 in. extension from cabinet

Weight: 150 lbs (approximate – cabinet only – does not include mounting box or optional table)

Power: Either 115V, 60 Hz or 230V, 50 Hz power required for fan assembly

MODELS CA and CB
RACK-MOUNTED (CABINET) SYSTEMS

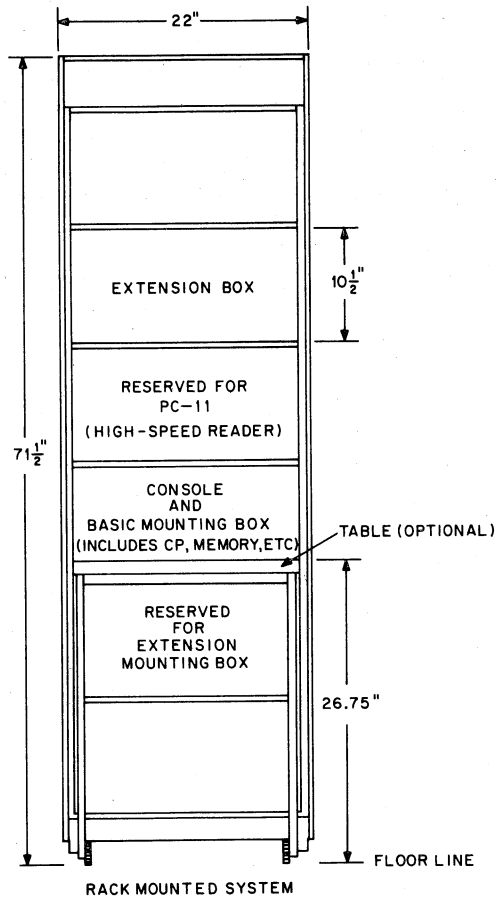

11-0096

DESCRIPTION

The LT33 Teletype Unit is one of the Teletypes that may be used with the PDP-11 System. This Teletype functions as an input/output device for communication with the system. The Teletype unit plugs into the rear of the PDP-11 System Mounting Box and therefore does not require a separate power receptacle.

MODEL TYPES

The LT33 Teletype is available in four models. The first letter of the model number indicates whether or not it has a paper tape capability. The second letter of the model number indicates the required input voltage.

Model	Type	Power	Description
LT33-DC	33 ASR	115V, 60 Hz	Automatic send/receive unit. Includes keyboard and a reader/punch for paper tapes.
LT33-DD	33 ASR	230V, 50 Hz	Same as above.
LT33-CC	33 KSR	115V, 60 Hz	Keyboard only. Does not include paper tape capability.
LT33-CD	33 KSR	230V, 50 Hz	Same as above.

SPECIFICATIONS

Size: 34 in. high, 22 in. wide, 19 in. deep

Weight: 56 lbs

Power: C Models – 115V \pm 10%, 60 Hz \pm 0.45 Hz

D Models – 230V \pm 10%, 50 Hz \pm 0.75 Hz

Both Models – Line current drain of 2A power dissipation of 150W

LT33 TELETYPE

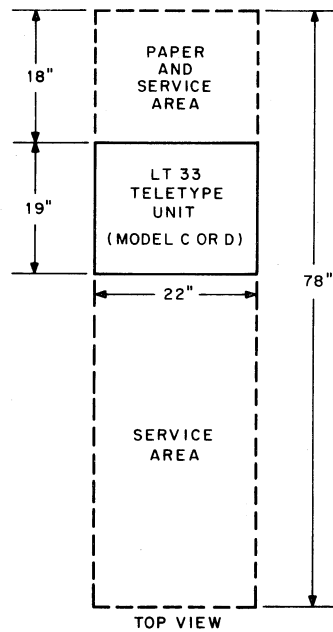
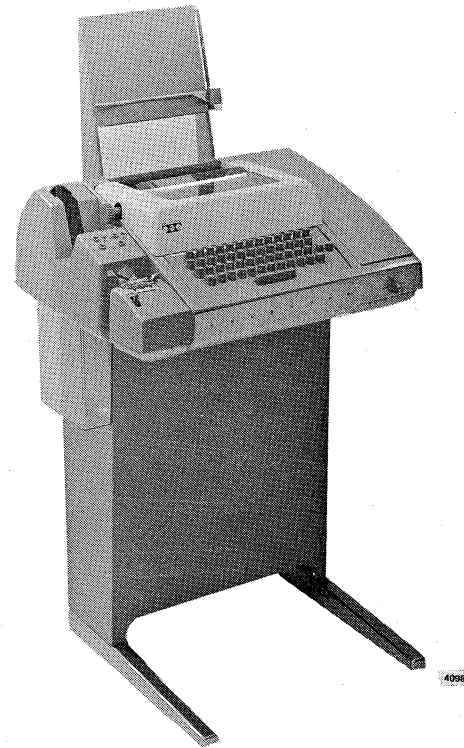

NOTE:
MUST BE WITHIN 8 FT. OF PDP-11
SYSTEM DUE TO CABLE
RESTRICTION.

11-0095

DESCRIPTION

The LT35 Teletype Unit is one of the Teletypes that may be used with the PDP-11 System. This Teletype functions as an input/output device for communication with the system and is basically a heavy-duty version of the LT33 Teletype. The unit plugs into the rear of the PDP-11 System Mounting Box and therefore does not require a separate power receptacle.

MODEL TYPES

The LT35 Teletype is available in four models. The first letter of the model number indicates whether or not it has a paper tape capability. The second letter of the model number indicates the required input voltage.

Model	Type	Power	Description
LT35-DC	35 ASR	115V, 60 Hz	Automatic send/receive unit. Includes keyboard and a reader/punch for paper tapes.
LT35-DD	35 ASR	230V, 50 Hz	Same as above.
LT35-CC	35 KSR	115V, 60 Hz	Keyboard only. Does not include paper tape capability.
LT35-CD	35 KSR	230V, 50 Hz	Same as above.

SPECIFICATIONS

Size: 40 in. high, 20 in. wide, 28 in. deep

Weight: 150 lbs

Power: C Models – 115V \pm 10%, 60 Hz \pm 0.45 Hz

D Models – 230V \pm 10%, 50 Hz \pm 0.75 Hz

Both Models – Line current drain of 2A power dissipation of 150W

LT35 TELETYPE

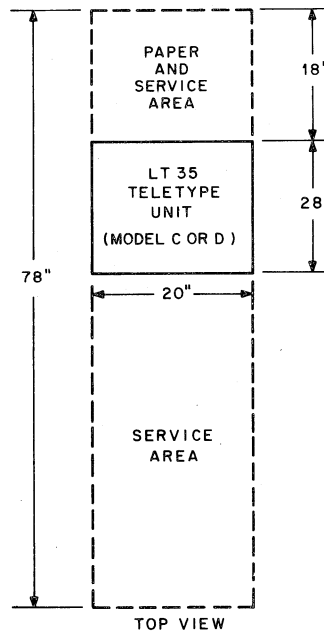

11-0094

H720 POWER SUPPLY (A and B Version)

DESCRIPTION

The H720 Power Supply provides both regulated and unregulated ac and dc power for the PDP-11 System. This supply furnishes all power required by components in either a basic or extension mounting box. The power supply is furnished as part of the basic mounting box, but must be ordered as an additional item when using either the BA11-ES or BA11-EC Extension Mounting Box.

INPUT VOLTAGE

Model A:	120 Vac, $\pm 10\%$; 47-63 Hz; 6A
Model B:	One of the following: 218 Vac, $\pm 10\%$; 47-63 Hz; 3A 225 Vac, $\pm 10\%$; 47-63 Hz; 3A 233 Vac, $\pm 10\%$; 47-63 Hz; 3A 240 Vac, $\pm 10\%$; 47-63 Hz; 3A

OUTPUT VOLTAGES (both models)

Regulated:	+5 Vdc, $\pm 5\%$; 16A -15 Vdc, $\pm 3\%$; 10A
Unregulated:	-22 Vdc, $\pm 20\%$; 1A +8V, full-wave rectified, unfiltered; 1.5A

PROTECTION CIRCUITS

Over-current:	+5V @ 18-22A; short-circuit current 30A at 0V -15V @ 12-16A; short-circuit current 25A at 0V
Over-Voltage:	+5 Vdc limited to 6.3 Vdc -15 Vdc limited to unregulated -22 Vdc

LOGIC SIGNALS

LTC:	Line frequency signal, sine wave clipped at +5V and ground
DC LO:	Low dc voltage signal, goes high before AC LO on power up; remains high 7 ms after AC LO drops during power down
AC LO:	Low ac voltage signal

AVAILABLE POWER

The basic PDP-11/20, consisting of the KA11, KY11-A, MM11-E, and KL11, allows the following power for expansion:

+5 Vdc, $\pm 5\%$;	3.4A
-15 Vdc, $\pm 3\%$;	1.7A
-22 Vdc, $\pm 20\%$, unregulated;	0.8A

DIMENSIONS

Size:	8 in. high, 16-1/2 in. wide, 6 in. deep
Weight:	25 lbs

H720 POWER SUPPLY
(E and F Version)

INPUT VOLTAGE

Model E: 120 Vac, $\pm 10\%$; 47-63 Hz; 6A
Model F: One of the following:
210 Vac, $\pm 10\%$; 47-63 Hz; 3A
225 Vac, $\pm 10\%$; 47-63 Hz; 3A
240 Vac, $\pm 10\%$; 47-63 Hz; 3A

OUTPUT VOLTAGES (both models)

Regulated: +5 Vdc, $\pm 5\%$; 22A
-15 Vdc, $\pm 3\%$; 10A
Unregulated: -22 Vdc, $\pm 20\%$; 1A
+8V, full-wave rectified, unfiltered; 1.5A

PROTECTION CIRCUITS

Over-current: -15V @ 12-16A; short-circuit current 25A at 0V
Over-Voltage: +5 Vdc limited to 6.3 Vdc
-15 Vdc limited to unregulated -22 Vdc

LOGIC SIGNALS

LTC: Line frequency signal, sine wave clipped at +5V and ground
DC LO: Low dc voltage signal, goes high before AC LO on power up;
remains high 7 ms after AC LO drops during power down
AC LO: Low ac voltage signal

AVAILABLE POWER

The basic PDP-11/20, consisting of the KA11, KY11-A, MM11-E, and KL11, allows the following power for expansion:

+5 Vdc, $\pm 5\%$;	9.4A
-15 Vdc, $\pm 3\%$;	1.7A
-22 Vdc, $\pm 20\%$, unregulated;	0.8A

DIMENSIONS

Size: 8 in. high, 16-1/2 in. wide, 6 in. deep
Weight: 30 lbs

**H960-CA
FREESTANDING BASE CABINET**

DESCRIPTION

This optional cabinet can be used to mount the BA11-CS Basic Mounting Box and a BA11-ES Extension Mounting Box, in addition to other PDP-11 equipment. If desired, the cabinet can be used to house only additional PDP-11 equipment. The cabinet contains six 10-1/2 in. high mounting spaces. If equipment is not mounted, each space can be covered by a black plastic panel. Five of these panels are supplied with the cabinet.

A photograph and installation drawing of this cabinet is contained in the Model CA and CB Rack-Mounted System data sheet.

COMPONENTS

- H950-A Frame
- H952-E Coasters
- H952-F Levelers
- H952-C Fan Assembly (located in top of cabinet)
- H950-S Filter
- H950-B Rear Door
- H952-A End Panel (2)
- H950-D Mounting Panel Doors
- H952-B Stabilizer Feet

- PDP-11 Logo
- Blank Plastic Bezels (10-1/2 in., maximum of 5 supplied)

- #7406782 Kick Plate
- #7005909 Power Distribution Panel (ac and dc; mounted on upper left side of cabinet)

SPECIFICATIONS

- Size:** 71-1/2 in. high, 22 in. wide, 39 in. deep (including stabilizer feet)
- Weight:** 150 lbs. (without any equipment mounted inside)
- Power:** Either 115V, 60 Hz or 230V, 50 Hz power is required for the fan assembly

**H952-HA
FREESTANDING PROGRAMMER'S TABLE**

DESCRIPTION

The H952-HA Freestanding Programmer's Table is an option that can be ordered for use with the H960-CA Base Cabinet. The table extends into the cabinet approximately one in. The surface plate is supported by its own adjustable-height legs. It should be noted that the table cannot be used by itself; it must be used with the base cabinet. During installation planning, it is necessary to note that the table extends 20 in. from the front of the cabinet, making the space needed for the cabinet 59 in. deep.

SPECIFICATIONS

Size: 27 in. high (above floor)
19 in. wide
21 in. deep (extends 20 in. from cabinet, 1 in. into cabinet)

**BA11-EC
EXTENSION MOUNTING BOX
(TABLE-TOP MODEL)**

DESCRIPTION

The Table-Top Extension Box provides mounting space for up to six additional system units which cannot be contained in the basic mounting box.

COMPONENTS

Each BA11-EC Extension Mounting Box is supplied with the following:

- Blank front panel
- Protective cover
- Cooling fans (4)
- Filter
- Unibus cable from basic mounting box (8 ft 6 in. long)
- 15 ft of power cord with ground wire (type of cord determined by type of H720 Power Supply selected)

SPECIFICATIONS

- Size:** 11 in. high, 20 in. wide, 24 in. deep
- Power:** Input power requirements are dependent on the type of H720 Power Supply ordered for the box.

**BA11-ES
EXTENSION MOUNTING BOX
(RACK-MOUNTABLE MODEL)**

DESCRIPTION

The Rack-Mountable Extension Box provides mounting space for up to six additional system units which cannot be contained in the basic mounting box.

COMPONENTS

Each BA11-ES Extension Mounting Box is supplied with the following:

- Blank front panel
- Tilt-and-lock chassis slides
- Cooling fans (4)
- Filter
- Unibus cable from basic mounting box (8 ft 6 in. long)
- 15 ft of power cord with ground wire (type of cord determined by type of H720 Power Supply selected)

SPECIFICATIONS

- Size:** 10-1/2 in. high, 19 in. wide, 23 in. deep
- Power:** Input power requirements are dependent on the type of H720 Power Supply ordered for the box.

Reader's Comments

Your comments and suggestions will help us in our continuous effort to improve the quality and usefulness of our publications.

What is your general reaction to this manual? In your judgment is it complete, accurate, well organized, well written, etc.? Is it easy to use? _____

What features are most useful? _____

What faults do you find with the manual? _____

Does this manual satisfy the need you think it was intended to satisfy? _____

Does it satisfy *your* needs? _____ Why? _____

Would you please indicate any factual errors you have found. _____

Please describe your position. _____

Name _____ Organization _____

Street _____ Department _____

City _____ State _____ Zip or Country _____

CUT OUT ON DOTTED LINE

Fold Here -----

Do Not Tear - Fold Here and Staple -----

**FIRST CLASS
PERMIT NO. 33
MAYNARD, MASS.**

**BUSINESS REPLY MAIL
NO POSTAGE STAMP NECESSARY IF MAILED IN THE UNITED STATES**

Postage will be paid by:

**Digital Equipment Corporation
Technical Documentation Department
146 Main Street
Maynard, Massachusetts 01754**

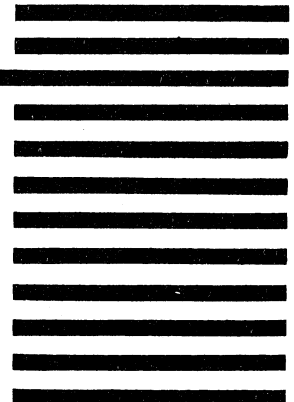

digital

digital equipment corporation