

FLOPPY DISK SUBSYSTEM

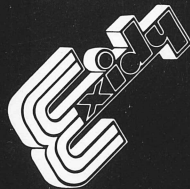

OPERATORS
MANUAL

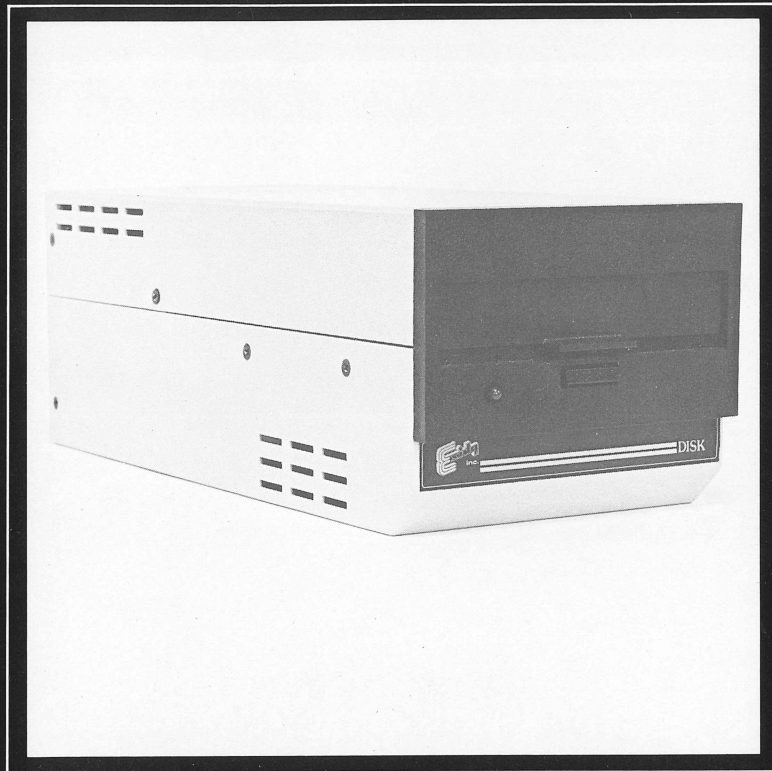

6

o



o

o



EXIDY FLOPPY DISK SUBSYSTEM: Operation Manual

- . Connects directly to the Sorcerer's 50-pin edge connector.
- . Has its own built-in controller card so it does not need an S-100 expansion unit.
- . Uses 5 1/4 inch soft sector single-sided floppy disks.
- . 308 kilobytes (quad density) per disk (formatted) for the 77 track per disk drive
- . 160 kilobytes (dual density) per disk (formatted) for the 40 track per disk drive
- . Stores any CP/M files, including Extended BASIC programs, Z80 assembly language and machine language programs, Word Processor files, COBOL-80 and FORTRAN-80 programs and files.

Copyright (c) 1980, EXIDY, Inc.

(CP/M is a registered trade mark of Digital Research, Pacific Grove, California.)

FEBRUARY 1980

TABLE OF CONTENTS

1. CONFIGURATION	3
1.1 General	3
1.2 Purpose of equipment	3
1.3 Configuration	3
1.4 Physical Descriptions	3
2. CHECKOUT	4
2.1 Unpacking	4
2.2 Installation and safety	4
2.3 Setting up	5
2.4 Floppy Disk Subsystem add-on	7
3. DISKETTE OPERATION	8
3.1 Operating instructions	8
3.1.1 Flexible diskette loading	8
3.1.2 Flexible diskette removal	8
3.2 Diskettes	9
3.3 Diskette handling recommendations	9
3.4 Back-up diskettes	9
4. TROUBLESHOOTING	10
5. SPECIFICATIONS	11
5.1 Model 6400	11
5.1.1 General	11
5.1.2 Power	11
5.1.3 Environmental	11
5.2 Model 6402	11
5.2.1 General	11
5.2.2 Power	11
5.2.3 Environmental	11
6. PHOTOGRAPHIC ILLUSTRATIONS	12

1. CONFIGURATION

1.1 General. This section gives a physical and functional description and specifications for Exidy's Floppy Disk Subsystem for the Sorcerer Computer.

1.1. Purpose of equipment. Exidy's Floppy Disk Drive is a compact disk memory device designed for random-access data storage, data entry and data-output applications. Typical applications are intelligent terminal controllers, micro-computers, word-processing systems, data communications systems, error logging, micro-program logging and point-of-sale terminals. Exidy's Floppy Disk Drive meets ANSI specifications.

1.3 Configuration. You can use your Floppy Disk Subsystem in two configurations:

1.3.1 One stand-alone unit. This uses a 50-conductor cable (supplied) from the Sorcerer to the unit and an AC power cord. The cord is supplied with the unit, but not attached to it.

1.3.2 One unit plus an add-on. There are two cables, a 34-pin flat cable and a 4-conductor power cable. These two run between the main unit and the add-on.

1.4 Physical Descriptions. The Floppy Disk Drive can be mounted vertically or horizontally. However, when mounted horizontally, we recommend that the Drive be positioned so that the PCB is on the bottom side.

To prevent accidentally erasing important data on a diskette, use a write protect tab, as shown in Figure 1. When a write protected diskette is inserted, the write protect sensor disables the write/erase circuits in the drive.

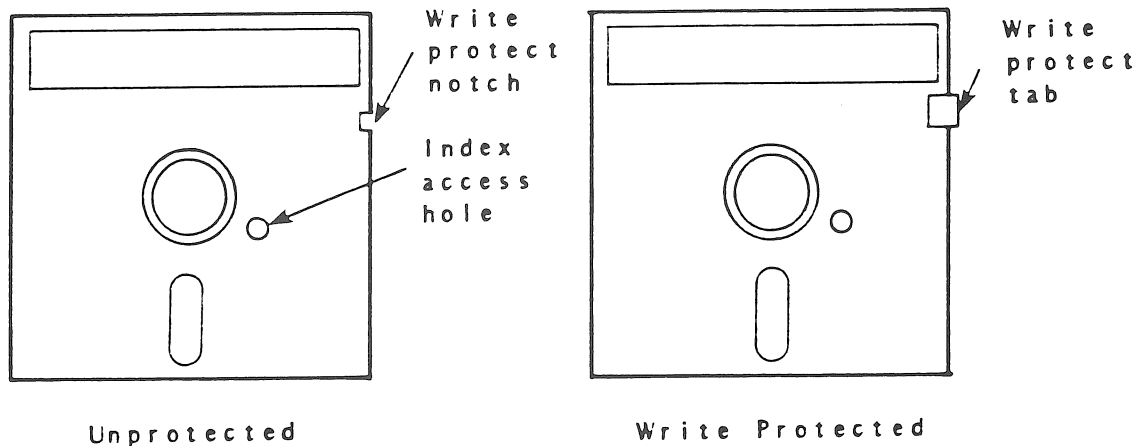

Figure 1: Write Protect Option

2. CHECKOUT

2.1 Unpacking. During unpacking be sure that all tools are non-magnetic and do not inflict damage to the unit. As you unpack the unit, inspect it for possible shipping damage; file all claims promptly with the transporter. Save the original packing material; the safest way to transport the unit is in its original packing.

Your Exidy Floppy Disk Subsystem comes packed in two protective cartons, one within the other, what is called "floater" packing. Foam is glued to the outside of the inner carton, and glued to these are corrugated pads which fit inside the outer carton, forming protective cushioning all around the inner carton. The dimensions of the outer carton are 11 1/2 x 10 1/4 x 22 1/4. The outer shipping carton can be opened carefully at the end with a sharp instrument. Carefully open the inner carton by hand, because a sharp instrument might damage the unit. After you open the end of the inner carton, if you see a foam pad, remove it. If you can easily slide the unit out, do so. If necessary, you may wish to open the other end and push the unit out.

Upon first opening the inner carton, you may encounter the rear of the unit, recognizable by the folded-up power cords and the heat sink (black metal louvers). Grasp the unit by the heat sink and gently pull it out.

The FDS unit comes with two cords, a flat 50-conductor cable and an AC power cord. These cords are not attached to the unit, and must be hooked up as explained below.

2.2 Installation and safety. Locate your equipment with both physical and electrical considerations in mind, paying attention to these points:

- 2.2.1 Never block or cover the air vents at the top and back of the Sorcerer or the Floppy Disk Subsystem.
- 2.2.2 Avoid dusty places, and do not place the equipment near radiators or other heat sources. Dust can damage diskettes and disk drives; overheating can affect performance.
- 2.2.3 Avoid smoking near the unit; smoke contaminates the drive's read/write heads and damages diskettes.
- 2.2.4 As with all electrical appliances, keep the unit away from moisture.
- 2.2.5 Never push anything into the unit through the air vents.
- 2.2.6 Never remove the top cover; the unit's electrical components may burn or shock you.

- 2.2.7 Protect the unit from falls and impacts.
- 2.2.8 During a thunderstorm, we recommend unplugging the Sorcerer and the Floppy Disk Subsystem, to protect from power line surges.
- 2.2.9 If the unit produces an abnormal sound or smell during operation, turn the power off, unplug the power cord, disconnect the unit from the Sorcerer and contact your dealer.
- 2.2.10 Do not use alcohol, benzene, thinner, chemical solvent or any other aromatics to clean the metal case. Do not use abrasives of any sort. A soft, non-abrasive cloth (cheesecloth is the best) dampened only slightly with a mild dishsoap solution is all you need; be sure to wipe dry with a similar, dry cloth.

2.3 Setting up.

- 2.3.1 Before plugging in the Sorcerer and the Floppy Disk Subsystem, determine whether you will be using 100, 110, 220 or 240 VAC. Your unit should have been shipped to the proper specifications. To change voltage operation, look at the rear of the unit. Directly to the right of the on/off switch is the AC power module, covered by a sliding plastic door. Remove the AC cord and slide the door over the power cord (three-pronged male) plug. Swing the lever marked "FUSE PULL" out and towards the door. This removes the fuse and allows the fuse lever to clear the PCB. Remove the AC power line select PCB (see photo). (The PCB is 1.6" x 0.8"--needle-nose pliers work well to remove the board, or a small hooked instrument inserted in the hole at the center of the closest edge of the board.) Each side of the PCB has printed on it one number: 100, 110, 220, 240. For 100 VAC operation, insert the board such that "100" is readable; for 110 VAC operation, insert the board with "110" readable; do the same for 220 or 240. The transformer handles 50 or 60 Hz equally well.

NOTE

Be certain never to turn either the unit or the Sorcerer on or off with a diskette engaged in the drive!

- 2.3.2 With all power off, do the following:
- 2.3.3 Supplied with your unit is a 50-conductor ribbon cable. Plug the 50-pin female connector into the fifty-pin male plug (two parallel rows of 25 pins

each) at the rear of the disk unit. Keep the cable flat. Attach the other end of the cable to the Sorcerer's 50-pin edge connector (labeled EXPANSION BUS).

- 2.3.4 A ground wire is attached at the back of the disk unit. Attach this wire to a ground on the back of the Sorcerer.
- 2.3.5 Attach the female end of the power cord to the three-pronged male plug at the back of the disk unit and connect the cord to the AC line.
- 2.3.6 Turn on the unit. Turn on the Sorcerer.
- 2.3.7 If you have a 48K Sorcerer, the top of RAM will no longer be at BFFF, but BEFF. (With smaller-memory Sorcerers, you will notice no difference.)
- 2.3.8 Ensure that front access door opens and closes.
- 2.3.9 Now you are ready to boot CP/M, your Disk Operating System (DOS), the interface between the disk drive and the computer. Insert a system diskette, following the instructions in Section 3.
- 2.3.10 When you see the Monitor prompt character (>), type GO BF00 <carriage return>. (BF00 is the GO ADDRESS or BOOT ADDRESS, used to bring up CP/M.)
- 2.3.11 The select light should come on on the front panel of the drive. The drive motor should come on, and you should hear a click (as the read/write head drops).
- 2.3.12 CP/M should come up, by displaying a sign-on message on the screen, which looks like this:

```
CP/M on Exidy Sorcerer for xx Track Disk
32K CP/M VERS 1.43/3
Copyright (C) 1980 Exidy Inc.
```

A>

(where xx is 40 or 77, and A> is the CP/M prompt, telling you that CP/M is up and awaiting a command.)
- 2.3.13 If the select light does not come on, turn off all power, and then try reversing one end of the 50-conductor cable (by giving the cable a half twist). If that doesn't work, see your dealer. Trying to repair the unit yourself will void your warranty.

2.4 Floppy Disk Subsystem Add-on. You may purchase from your Exidy dealer or distributor an optional add-on disk drive unit. This unit comes with a 34-conductor cable and a power cord. The add-on receives DC power from the main unit and does not require voltage adjustment (as explained in 2.3.1).

Attaching the add-on unit requires removing the cases of both units. You should have your dealer do this for you.

When the two units are hooked up, you may access the second as described in the publication An Introduction to CP/M Features and Facilities.

NOTE

Please do not attempt to repair or modify your drive. Doing so will void your warranty.

3. DISKETTE OPERATION

3.1 Operating instructions. Secure both power and I/O connectors prior to disk loading.

3.1.1 Flexible diskette loading.

3.1.1.1 Apply power to drive.

3.1.1.2 Open drive door by pushing door latch button.

3.1.1.3 Remove diskette from its storage envelope and insert in the drive. The index hole and tab must be on the left side of the jacket and the label on the upper surface. Push the diskette gently forward until a "click" is heard. (See Figure 2.)

3.1.1.4 Close door by pushing door down until latch secures the door. (This engages the diskette.)

3.1.2 Flexible diskette removal.

3.1.2.1 Open the drive door by pushing door latch button (beneath door). The flexible diskette automatically ejects so that it can be easily removed.

3.1.2.2 Always store diskettes in envelopes to protect the data.

3.1.2.3 Close drive door.

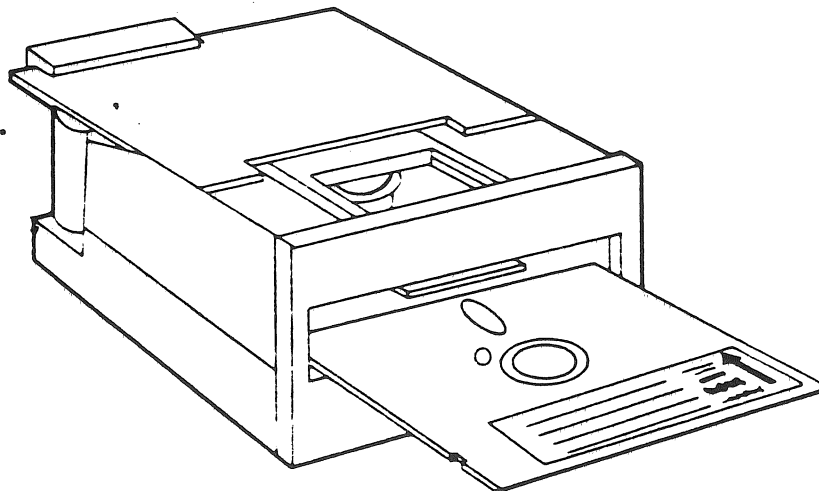

Figure 2: Diskette Orientation

3.2 Diskettes. The Exidy Floppy Disk Subsystem uses industry standard 5 1/4 inch single-sided quad or double density (or high quality single density rated) soft-sectored diskettes, available from your Exidy dealer.

The disk drive has a write protect feature, which protects diskettes from accidental alteration or erasure. Each package of diskettes comes with special write protect tabs; to protect a diskette, place a tab over the diskette's write protect cutout, as in Figure 1.

Diskettes wear out in time, as any magnetic recording medium. The disk drive has an automatic feature which raises the read/write head off the diskette when there has been no read or write to the drive for three seconds, thus extending the life of the diskette.

3.3 Diskette handling recommendations. To protect the information on the diskette, use reasonable care in handling. Follow these recommendations for longer diskette life and trouble-free operation:

3.3.1 Write on diskette jacket label first, and then fasten it to the diskette. (Excessive pressure can damage diskette.)

3.3.2 Do not use a writing device which deposits flakes (as lead or grease pencils) to write on a diskette jacket label.

3.3.3 Do not fasten paper clips to diskette jacket edges.

3.3.4 Do not touch diskette surface exposed by jacket slot.

3.3.5 Do not clean diskette in any manner.

3.3.6 Protect diskette from magnetic fields.

3.3.7 Return diskette to envelope when removed from drive.

3.3.8 At all times protect diskette from liquids, dust and metallic substances.

3.3.9 Do not exceed these storage environmental conditions:

Temperature: 50^o to 125^oF (10^o to 51^oC)

Relative humidity: 8 to 80%

Maximum wet bulb: 85^oF (29.4^oC)

3.3.10 Store diskette when not in use.

3.4 Back-up diskettes. Since diskettes wear out in time, we recommend making back-up copies of system diskettes and other important diskettes, and frequently updating them.

4. TROUBLESHOOTING

4.1 Only qualified technicians should attempt major repairs and adjustments to the unit, because doing so will void your warranty. This section discusses minor problems that may arise with your FDS unit, and suggests solutions.

4.2 Motors do not turn and drive select light(s) do(es) not light. The probable cause is no power to unit.

4.2.1 Check the power cord.

4.2.2 Check the fuse.

4.2.3 Check the AC power line select PCB (see 1.2.a) for correct line voltage.

4.3 Power is on but drive does not select and CP/M does not come up. The fifty-conductor cable may be connected wrong.

4.3.1 Turn off all power.

4.3.2 Give cable a half-turn as in 2.3.13.

4.4 Drive select lights never light. This can be caused by a disconnected fifty-conductor cable, controller malfunction, Sorcerer malfunction, or disconnected ground wire.

4.4.1 Ensure that fifty-conductor cable is connected.

4.4.2 The controller should be tested and, if necessary, repaired by a dealer or Exidy.

5. SPECIFICATIONS

5.1 Model 6400

5.1.1 General

Parameter	Characteristics
Medium	ANSI standard 5 1/4-inch diskette
Number of tracks	40
Track density	48 TPI
Start/stop time	.5 sec
Rotational speed	300 rpm \pm 1.5%
Average rotational latency	100 msec
Head loading time	35 msec
Access time	5 msec, track-to-track
Head settling time	15 msec
Recording method	MFM
Data-transfer rate	250K bits/sec

5.1.2 Power

100, 110, 220 or 240 VAC
50/60 Hz

5.1.3 Environmental

Parameter	Characteristics
Operating temperature	40° to 115°F (4.4° to 46.1°C)
Relative humidity	20 to 80% (noncondensing)

5.2 Model 6402

5.2.1 General

Parameter	Characteristics
Medium	ANSI standard 5 1/4-inch diskette
Number of tracks	77
Track density	100 TPI
Start/stop time	1.5 sec
Rotational speed	300 rpm \pm 1.5%
Average rotational latency	100 msec
Head loading time	75 msec
Access time	30 msec, track-to-track
Head settling time	10 msec
Recording method	MFM
Data-transfer rate	250K bits/sec

5.2.2 Power

100, 110, 220 or 240 VAC
50/60 Hz

5.2.3 Environmental

Parameter	Characteristics
Operating temperature	50° to 104°F (10° to 40°C)
Relative humidity	20 to 80% (noncondensing)

1. Floppy Disk Subsystem connected to Sorcerer's expansion bus edge connector.

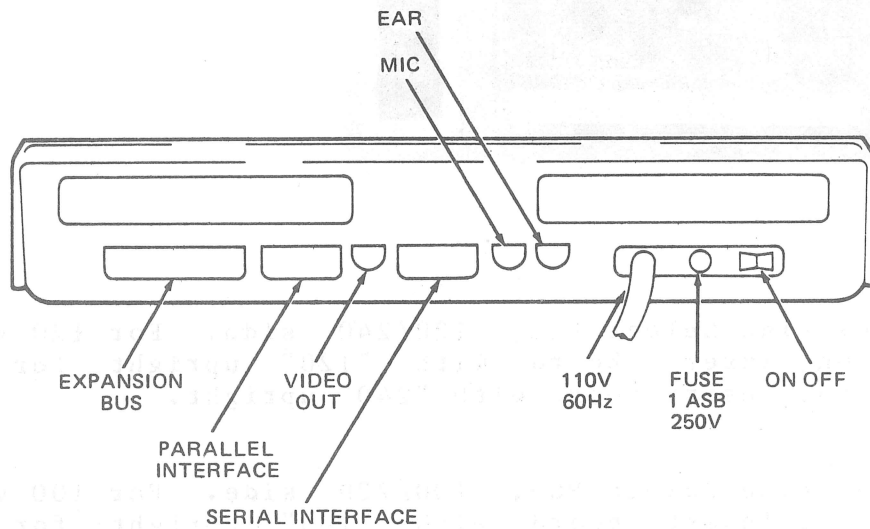
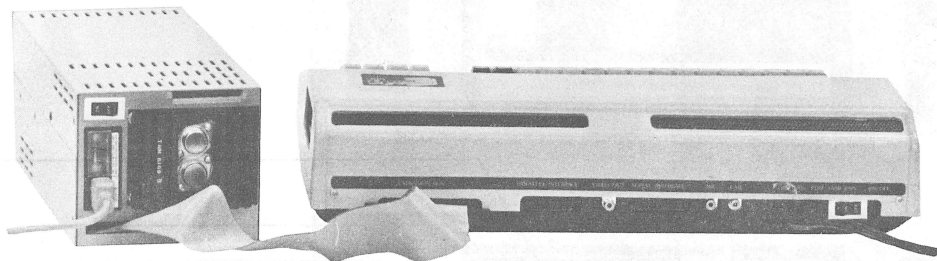

Rear of Sorcerer Computer

2, 3, 4: Removal of AC Power Line Select PCB.

2. AC Power Module covered by sliding door.

3. Slide plastic door down over power cord plug.

4. Swing fuse-removal-lever out and down to remove fuse. Remove PCB with a hooked instrument or needle-nose pliers.

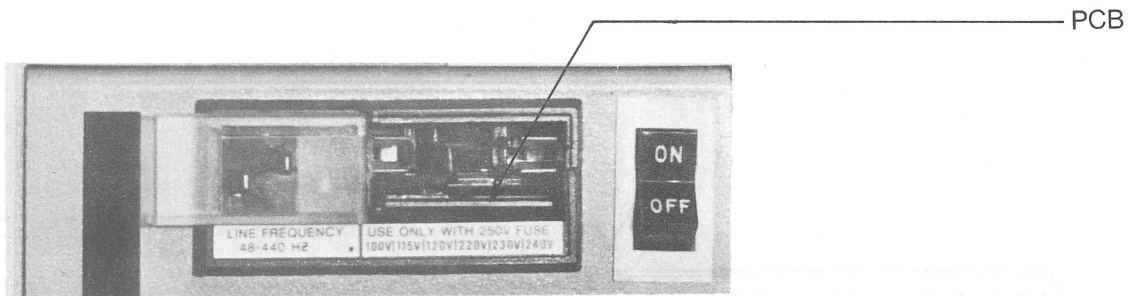
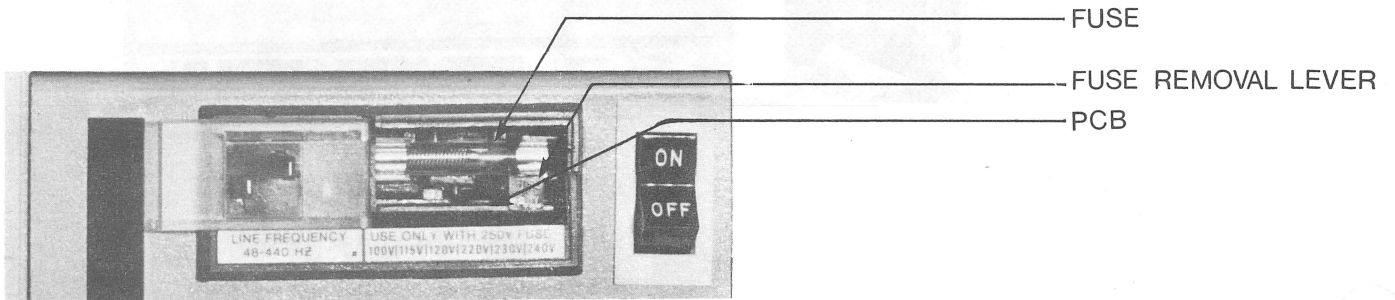
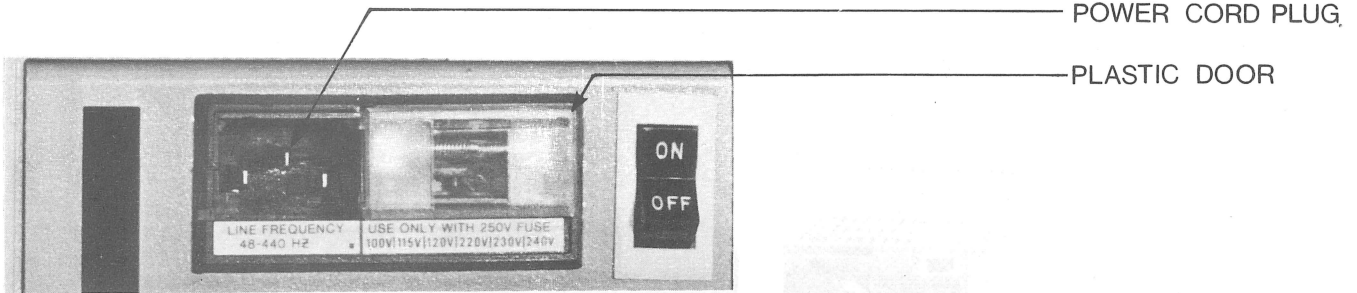

5. AC Power Line Select PCB, 120/240 side. For 120 volts AC operation, insert board with "120" upright; for 240 VAC operation, insert board with "240" upright.

6. AC Power Line Select PCB, 100/220 side. For 100 volts AC operation, insert board with "100" upright; for 220 VAC operation, insert board with "220" upright.

